

MaxMotion

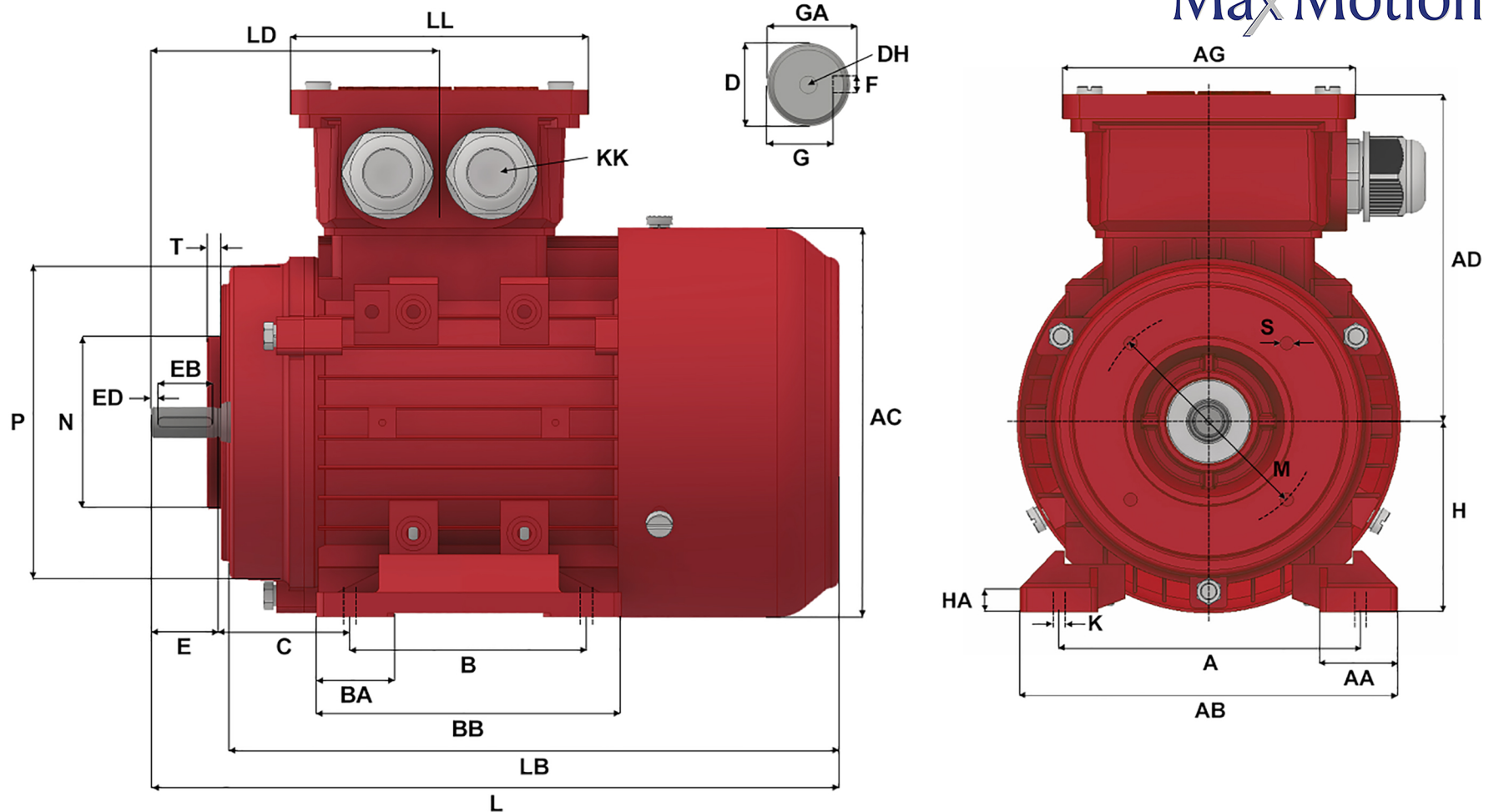

Version: 1JLEM		Revised: 09-11-2019				HP	RPM	FRAME	ENCLOSURE	IJA562-2-B34A		
Customer is responsible in determining that Max Motion product will fit/perform suitably in the intended application						0.18	3240	56	TEFC			
A	B	C	D	E	F	G	H	K	L	M	N	P
90	71	36	9	20	3	7.2	56	5.8 X 8.3	199	65	50	80
S	T	AA	AB	AC	AD	AG	BA	BB	DH	EB	ED	GA
M5	2.5	23	111	113	97	86	22.5	88	M4 X 12	16	2	10.2
HA	KK (1)	KK (2)	KK (3)	LB	LD	LL						
7	M20 X 1.5	1/2" NPT	-	178.5	83	86						